

ZETA 1.3"

Pendant | Architectural LED Linear



Zeta series 1.3" linear pendant lighting is a unique linear series that brings any space to the center stage. These timeless, streamlined forms blend well with contemporary decors and modern workplaces. These linear luminaries is available in 2ft, 4ft and 8ft, simply provide wide, powerful lighting to any atmosphere with continuous runs. It can provide smooth uplight and downlight, allowing for wider spacing between fixtures and better ceiling light uniformity. Unleash lighting design flexibility with Zeta with different shapes and patterns, it adds fun factor into each room. These creations will let you suggest rhythm, communicate meaning and showcase element of life.

Feature

- 2ft, 4ft and 8ft lengths, up to 1200lm/ft
- Available in diffuser, louver, micro reflector and convex
- Multiple lighting distributions options
- Individual units or continuous runs
- Custom pattern with optional Line, L, X, T, Y, V joiners
- Optional wattage selectable (50%/75%/100%), emergency and sensor



PERFORMANCE

Lens	Lumen Output				
	50% UP/50%DOWN	25% UP/75%DOWN	75% UP/25%DOWN	100%DOWN	100%UP
Diffuser	1050lm/ft, 10w/ft	850lm/ft, 10w/ft	1100lm/ft, 10w/ft	800lm/ft, 10w/ft	1100lm/ft, 10w/ft
Louver	1000lm/ft, 10w/ft	750lm/ft, 10w/ft	1100lm/ft, 10w/ft	700lm/ft, 10w/ft	N/A
Micro Reflector	1200lm/ft, 10w/ft	1050lm/ft, 10w/ft	1200lm/ft, 10w/ft	1050lm/ft, 10w/ft	N/A
Convex	1150lm/ft, 10w/ft	1000lm/ft, 10w/ft	1150lm/ft, 10w/ft	950lm/ft, 10w/ft	N/A

Above are subject to 3500K with 50% up and 50% down lighting distribution. All efficacy is ±5% base on different CCT and lighting distributions. Check the IES file to gain the accurate data .

ZETA 1.3"

Pendant | Architectural LED Linear



PRODUCT PERFORMANCE

► Optics

It offers a selection of professional lens such as diffuser, louver, micro reflector and convex to meet your different requires.

► Finish

- Extruded aluminum housing.
- Powder coat white and black finish or custom.

► Electrical

LED Driver	It is powered by Class 2 high efficiency LED driver, with a standard 1-10V dimming which continuous dims to 10% that works with many types of controls. Tested Dimmers: Lutron ® Diva-Dvtv, Leviton ® IP-710-DL.
THD	<20%
Power Factor	>0.9
Input Voltage	Standard electronic drivers are cULus recognized and available for 110-277V or 110-347V*AC

► Mounting

- Pendant-Dry ceiling or T-Grid ceiling compatible. Cable lengths of 5ft is standard, 12ft or others are available
- Individual or continuous run, up to 40ft in 120VAC, 100ft in 277VAC
- Custom Pattern with optional Line, L, X, T, V, Y joiners.

► LED System

CRI	Minimum 80 color rendering index
CCT	The choice of 3000K, 3500K, 4000K color temperature with a great color consistency.
LED	Life Minimum 50,000h with 87.8% of lumen maintenance in 25°C ambient temperature, in compliance with IES LM-80 testing measurements.

► Approvals

- cULus listed for damp locations
- 5 years limited warranty

► Optional Function

Emergency Option	Optional high voltage emergency LED driver can be provided. When AC power fails, it immediately switches to the emergency mode, operating for lighting up to 120 minutes. When AC power is restored, it automatically returns to the charging mode which meets critical life-safety lighting requirements. For more info or spec sheet, please visit our website or contact sales.
------------------	--



Occupancy Sensor



Wattage Selectable Option

We can provide a factory-installed integrated sensor system for multi-level control based on motion and/or daylight contribution with BR1810BI-level & daylight harvest microwave sensor from SHARKWARD. For more info or spec sheet, please contact sales.

Available to adjust wattage to 100% ,75% and 50 % by dip switch.

PRODUCT ORDERING GUIDE

Sample

Z	E	-	4	1	-	I	35	A	D
1	2	3	4	5	6	7			
Z	E	-		1	-	I		A	
1	2	3	4	5	6	7			

1. Base Model

ZE ZETA

2. Length

2 2 feet 4 4 feet 8 8 feet

3. Width

1 1.3 inch

4. Driver

I Internal

5. CCT

30 3000K * 35 3500K 40 4000K

6. Light Distribution

- D 100% Downlight * A Uplight and Downlight
- U 100% Uplight * 50% down, 50% up *
- 75% down, 25% up
- 25% down, 75% up *
- Customize _____% down, _____% up*

7. Optics Options

- D Diffuser R Micro Reflector
- L Louver * C Convex *

OPTIONAL ORDERING GUIDE

Ceiling Type

- Dry Wall (Mount to J-box)
- Drop Ceiling Clips (Suitable for 9/16" and 15/16" Flat Ceiling)
- Drop Ceiling Clips (Suitable for 9/16" Slot Ceiling)
- Drop Ceiling Clips (Suitable for 15/16" Slot Ceiling) *

Canopy

- 1.6" Round 4.5" Round (Designed for power cable)
- 5.8" Round With Occupancy Sensor (Power Feed)
- 1.6" Square 4.5" Square (Designed for power cable)

Joiner

- "-" pattern "T" pattern "X" pattern
- "Y" pattern "L" pattern "V" pattern *

Optional Accessory

Rolling Diffuser (42')

Optional Functions

- LED Emergency Driver (Order Separated)
- Occupancy Sensor (Order Separated)
- Wattage Adjustable*

*Additional cost and/or lead time on customized fixtures may apply. Some fixtures require an MOQ. Please contact your sales rep for more information.

ZETA 1.3"

Pendant | Architectural LED Linear



DIMENSIONS

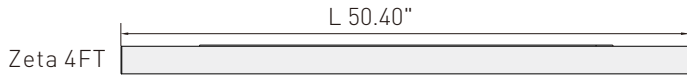
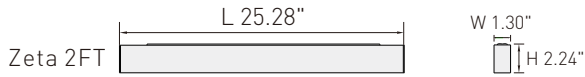

MOUNTING

Canopy Style

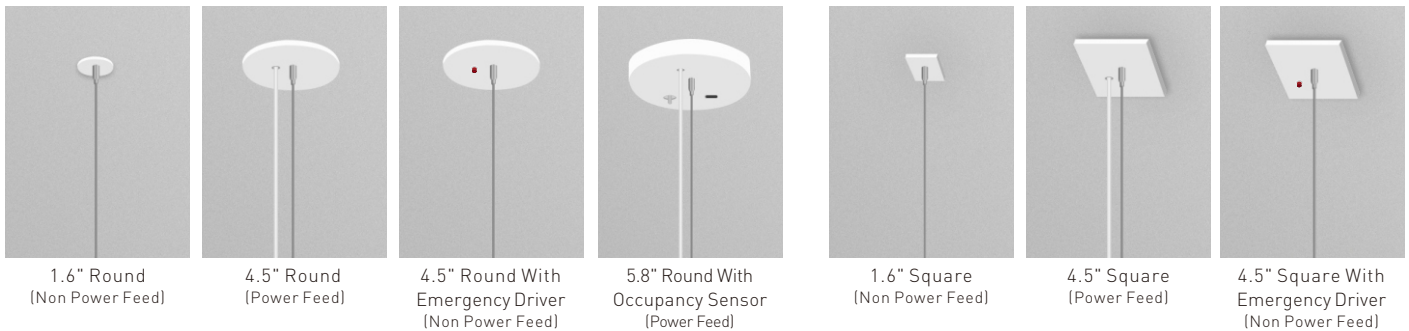

Dry Ceiling / Off Grid

"Various Hard Ceilings"
(Mount to J-box)

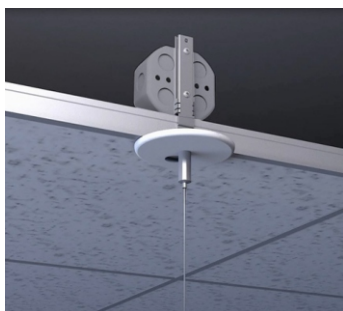
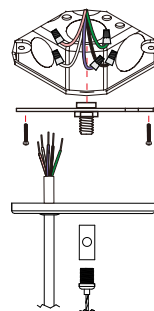
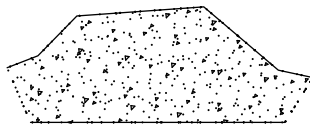

Drop Ceiling / On Grid

Suspending the luminaire in the T-grid. Compatible for various T-grid, including 9/16" Flat, 9/16" Slot, 15/16" Flat.

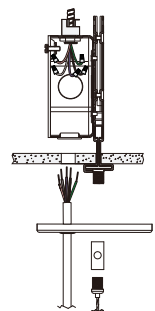
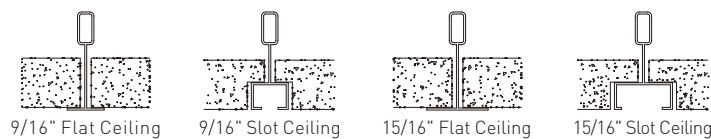

*Please see the installation instruction for more details.

ZETA 1.3"

Pendant | Architectural LED Linear



Standard Line Runs In 120v

Luminaire Run Length (ft)	Run Configuration	Line Joiner	5' Power Cable	5' Aircraft Cable	Canopy
2	2'	-	1	2	2
4	4'	-	1	2	2
6	4'+2'	1	1	3	3
8	8'	-	1	2	2
10	8'+2'	1	1	3	3
12	8'+4'	1	1	3	3
14	8'+4'+2'	2	1	4	4
16	8'+8'	1	1	3	3
18	8'+8'+2'	2	1	4	4
20	8'+8'+4'	2	1	4	4
22	8'+8'+4'+2'	3	1	5	5
24	8'+8'+8'	2	1	4	4
26	8'+8'+8'+2'	3	1	5	5
28	8'+8'+8'+4'	3	1	5	5
30	8'+8'+8'+4'+2'	4	1	6	6
32	8'+8'+8'+8'	3	1	5	5
34	8'+8'+8'+8'+2'	4	1	6	6
36	8'+8'+8'+8'+4'	4	1	6	6
38	8'+8'+8'+8'+4'+2'	5	1	7	7
40	8'+8'+8'+8'+8'	4	1	6	6
42	8'+8'+8'+8'+8'+2'	5	2	7	7
44	8'+8'+8'+8'+8'+4'	5	2	7	7
46	8'+8'+8'+8'+8'+4'+2'	6	2	8	8
48	8'+8'+8'+8'+8'+8'	5	2	7	7

Note: 4.5" canopy is designed for power cable

Individual

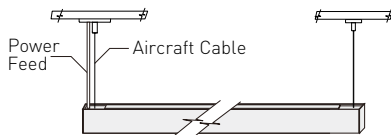

Continuous Run

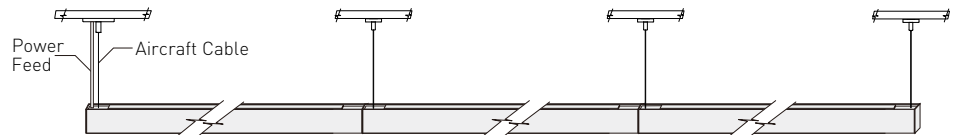

120VAC: Connections up to 40ft.
277VAC: Connections up to 100ft.

Custom Pattern With Joiners

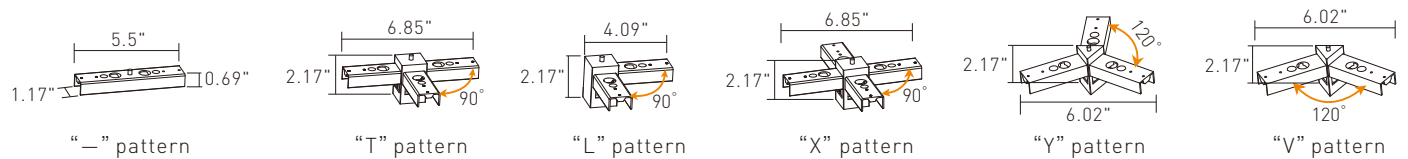

ZETA 1.3"

Pendant | Architectural LED Linear



DISTRIBUTION DIAGRAM

4' / Diffuser/50% Up,50% Down/ 3500K

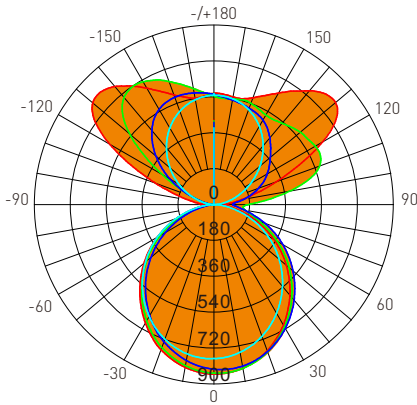

AVERAGE BEAM ANGLE(50%): 360.0°

Test Number: ZE-41-I35AD
 Lumens: 4509.4 Lm
 Watts: 40 W
 LPW: 112.735 Lm/W
 CCT: 3500K

UNIT: cd
 — C0/180, 360°
 — C30/270, 360°
 — C60/240, 360°
 — C90/270, 360°

Zonal Flux Diagram

T	C0	C45	C90	C135	C180
5	846.7	842.0	766.9	713.5	844.2
10	833.7	833.4	753.0	674.0	829.3
15	811.5	815.6	731.7	629.2	805.5
20	780.7	789.8	703.5	580.3	775.7
25	742.3	756.2	699.1	528.1	734.9
30	697.2	715.4	629.1	472.5	687.6
35	647.2	669.0	584.3	414.7	635.3
40	593.0	617.9	535.5	355.1	579.0
45	535.2	562.3	483.0	293.8	519.8
50	474.6	503.8	427.6	230.8	458.3
55	411.7	442.7	369.7	170.0	394.7
60	347.1	379.4	309.6	112.3	329.3
65	281.4	314.5	248.5	60.01	261.8
70	216.0	248.5	187.2	16.79	196.1
75	152.1	193.4	126.7	1.266	133.3
80	100.4	150.4	72.53	0.8480	83.59
85	65.09	130.9	28.39	7.141	48.45
90	49.45	142.5	0.7812	22.35	45.07
95	83.24	200.2	16.71	47.98	77.06
100	136.5	272.8	46.97	94.45	125.8
105	217.0	328.8	84.19	171.1	199.5
110	329.8	369.5	125.3	265.2	308.7
115	472.3	400.9	168.7	359.6	446.1
120	629.6	426.9	213.1	435.6	601.3
125	748.1	444.9	257.5	489.4	728.1
130	796.3	454.1	302.6	525.9	793.2
135	786.9	460.3	344.4	551.5	800.5
140	745.2	469.9	384.8	571.8	773.4
145	696.0	485.0	422.5	576.1	726.1
150	646.5	505.8	455.7	570.6	673.5
155	603.7	524.4	484.3	560.4	625.9
160	570.0	534.9	508.0	550.7	585.6
165	549.5	534.2	526.5	542.8	558.2
170	548.2	534.8	539.3	537.3	542.6
175	556.4	538.4	546.7	539.9	546.5
180	556.9	556.9	556.7	556.8	556.9
DEG	LUMINOUS INTENSITY:cd				

Zonal Lumens

T	φ total
0-5	18.99
5-10	75.19
10-15	166.5
15-20	289.3
20-25	439.3
25-30	610.8
30-35	797.5
35-40	993.1
40-45	1191
45-50	1384
50-55	1567
55-60	1733
60-65	1878
65-70	1999
70-75	2094
75-80	2165
80-85	2217
85-90	2257
90-95	2300
95-100	2358
100-105	2440
105-110	2553
110-115	2699
115-120	2877
120-125	3076
125-130	3287
130-135	3497
135-140	3698
140-145	3882
145-150	4045
150-155	4186
155-160	4302
160-165	4392
165-170	4457
170-175	4496
175-180	4509
	UNIT: lm

Luminance cd/(m2)

G(DEG)	C0/180	C90/270
85	17781	7755
80	13772	9945
75	13996	11657
70	15039	13029
65	15855	13998
60	16529	14742
55	17092	15347
50	17579	15840
45	18022	16264

ZETA 1.3"

Pendant | Architectural LED Linear



DISTRIBUTION DIAGRAM

4' / Louver/50% Up,50% Down/ 3500K

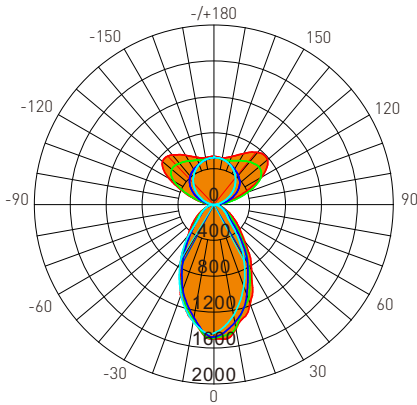

AVERAGE BEAM ANGLE(50%): 113.5°

Test Number: ZE-41-I35AL
 Lumens: 4049.2 Lm
 Watts: 40 W
 LPW: 101.23 Lm/W
 CCT: 3500K

UNIT: cd
 — C0/180, 277.5°
 — C30/270, 58.7°
 — C60/240, 58.7°
 — C90/270, 59.2°

Zonal Flux Diagram

τ	C0	C45	C90	C135	C180
5	1505	1444	1364	1301	1449
10	1402	1380	1256	1172	1323
15	1301	1236	1121	1028	1212
20	1177	1074	973.1	872.2	1085
25	1023	938.4	816.8	695.4	883.2
30	840.4	770.4	661.1	551.1	748.9
35	701.0	598.7	497.4	418.0	573.6
40	525.1	456.5	338.0	316.8	449.4
45	420.5	341.8	235.7	242.5	370.8
50	345.4	255.2	193.6	189.3	299.0
55	273.9	197.1	159.5	150.6	235.2
60	213.3	158.2	128.0	118.8	179.5
65	159.3	125.7	99.98	90.44	130.3
70	114.0	96.30	74.38	64.62	94.13
75	85.51	71.01	50.79	41.15	63.15
80	64.92	54.37	30.94	20.70	43.37
85	52.57	44.71	12.50	11.59	29.74
90	49.50	43.02	2.053	26.86	40.57
95	82.83	89.73	16.82	60.19	74.37
100	135.7	161.5	46.16	116.8	123.1
105	215.2	248.4	82.80	200.1	194.6
110	324.4	331.4	123.8	287.4	296.4
115	462.2	398.5	168.4	368.2	423.3
120	610.2	445.2	212.9	429.5	572.7
125	722.1	476.0	256.9	468.1	690.5
130	779.4	496.3	299.7	493.0	747.9
135	787.3	510.3	340.4	509.2	753.3
140	759.5	513.4	377.8	519.2	723.9
145	714.4	510.3	411.9	519.7	680.6
150	657.0	506.0	441.9	517.3	635.7
155	608.5	502.6	467.9	514.8	593.3
160	569.9	501.6	489.2	511.6	562.0
165	543.4	507.2	506.0	512.8	539.7
170	529.7	516.1	518.3	518.5	532.6
175	533.4	523.8	524.1	525.4	536.3
180	539.5	539.3	539.2	539.3	539.5
DEG	LUMINOUS INTENSITY:cd				

Zonal Lumens

τ	φ total
0-5	34.31
5-10	131.8
10-15	280.4
15-20	465.3
20-25	669.0
25-30	873.8
30-35	1065
35-40	1232
40-45	1370
45-50	1484
50-55	1581
55-60	1663
60-65	1731
65-70	1784
70-75	1825
75-80	1853
80-85	1873
85-90	1888
90-95	1911
95-100	1953
100-105	2025
105-110	2133
110-115	2280
115-120	2461
120-125	2666
125-130	2880
130-135	3089
135-140	3284
140-145	3460
145-150	3615
150-155	3746
155-160	3854
160-165	3938
165-170	3999
170-175	4037
175-180	4049
	UNIT: lm

Luminance cd/(m2)

G(DEG)	C0/180	C90/270
85	14360	3414
80	8902	4243
75	7866	4672
70	7937	5178
65	8973	5633
60	10157	6097
55	11370	6621
50	12794	7171
45	14159	7936

ZETA 1.3"

Pendant | Architectural LED Linear



DISTRIBUTION DIAGRAM

4' / Micro Reflector / 50% Up,50% Down/ 3500K

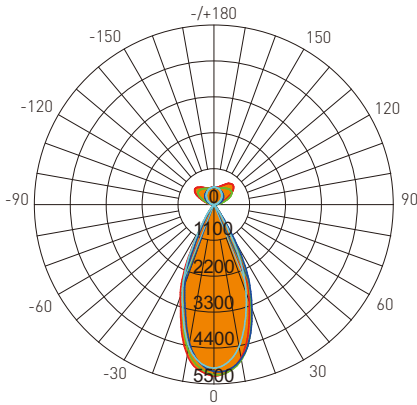

Test Number: ZE-41-I35AR
 Lumens: 4958.9 Lm
 Watts: 40 W
 LPW: 123.97 Lm/W
 CCT: 3500K

UNIT: cd
 C0/180, 45.7°
 C30/270, 45.5°
 C60/240, 45.0°
 C90/270, 44.2°

Zonal Flux Diagram

τ	C0	C45	C90	C135	C180
5	5135	5142	4858	4568	5105
10	4771	4875	4424	3822	4699
15	4073	4318	3706	3001	3885
20	3172	3450	2892	2071	3028
25	2233	2552	1937	951.5	2042
30	982.2	1326	867.0	346.2	838.3
35	379.1	462.7	595.9	113.2	331.0
40	75.80	148.4	82.03	31.71	61.07
45	16.73	39.27	19.68	12.14	16.12
50	9.085	14.31	8.995	7.277	8.885
55	6.277	8.058	5.823	4.940	6.052
60	4.512	5.466	4.075	3.525	4.265
65	3.707	3.808	3.140	2.804	3.454
70	2.964	2.876	2.504	2.177	2.678
75	4.411	3.202	1.904	1.591	3.691
80	10.56	8.789	1.340	1.671	10.87
85	22.76	21.85	0.9070	8.571	26.92
90	40.91	46.40	0.4270	26.34	52.84
95	71.67	93.46	16.03	63.10	94.24
100	118.6	172.1	45.59	126.2	154.2
105	188.9	260.6	82.41	214.5	238.9
110	286.2	343.8	123.9	303.1	353.2
115	409.1	411.7	167.9	380.5	491.1
120	558.5	459.2	212.8	437.4	631.6
125	693.0	491.4	257.4	473.5	726.5
130	790.6	515.6	301.8	496.4	761.3
135	839.2	529.2	343.0	512.6	745.3
140	833.6	530.2	381.7	521.1	700.4
145	797.3	525.2	416.9	522.0	653.2
150	729.3	517.4	448.3	519.2	605.0
155	660.6	512.3	475.3	516.1	568.9
160	608.8	510.1	497.9	514.6	541.9
165	567.6	514.7	515.8	518.9	529.5
170	542.0	525.0	528.5	529.0	534.6
175	534.2	535.7	535.9	537.7	543.3
180	541.4	541.0	540.2	540.3	541.5
DEG	LUMINOUS INTENSITY:cd				

Zonal Lumens

τ	φ total
0-5	119.8
5-10	458.4
10-15	951.0
15-20	1507
20-25	2027
25-30	2397
30-35	2591
35-40	2673
40-45	2700
45-50	2708
50-55	2712
55-60	2714
60-65	2716
65-70	2718
70-75	2719
75-80	2721
80-85	2726
85-90	2737
90-95	2760
95-100	2804
100-105	2880
105-110	2993
110-115	3144
115-120	3331
120-125	3541
125-130	3760
130-135	3975
135-140	4177
140-145	4358
145-150	4516
150-155	4650
155-160	4760
160-165	4846
165-170	4908
170-175	4946
175-180	4959
UNIT: lm	

Luminance cd/(m2)

G(DEG)	C0/180	C90/270
85	6218	248
80	1448	184
75	406	175
70	206	174
65	209	177
60	215	194
55	261	242
50	337	333
45	563	663

ZETA 1.3"

Pendant | Architectural LED Linear



DISTRIBUTION DIAGRAM

4' / Convex / 50% Up, 50% Down / 4000K

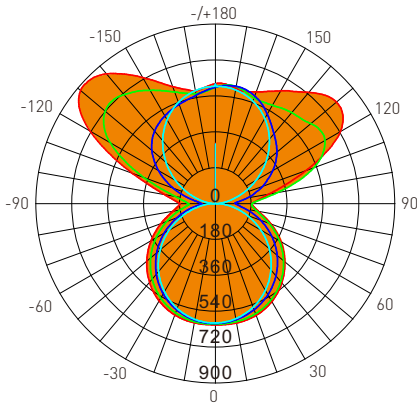

AVERAGE BEAM ANGLE(50%): 360.0°

Test Number: ZE-41-I40AC
 Lumens: 4690.1 Lm
 Watts: 40 W
 LPW: 117.25 Lm/W
 CCT: 4000K

UNIT: cd
 — C0/180, 360°
 — C30/270, 360°
 — C60/240, 360°
 — C90/270, 360°

Zonal Flux Diagram

τ	C0	C45	C90	C135	C180
5	600.7	598.1	596.5	596.8	600.1
10	600.1	593.6	587.6	589.3	599.0
15	596.6	586.5	573.6	577.0	595.2
20	588.9	576.2	554.7	560.3	586.8
25	576.8	562.0	531.3	539.1	574.2
30	559.7	543.5	503.0	513.4	556.6
35	538.1	521.0	471.0	483.9	534.5
40	512.1	494.3	435.3	450.7	508.0
45	482.0	463.9	396.1	414.1	477.7
50	448.6	429.9	354.3	375.0	444.0
55	411.8	392.8	310.1	333.5	407.3
60	372.7	353.0	262.6	290.5	368.1
65	331.7	311.3	215.5	246.3	327.1
70	291.1	267.6	168.4	204.4	286.9
75	250.9	224.4	122.2	164.8	246.3
80	216.2	186.8	79.17	126.7	211.2
85	192.5	161.5	39.94	97.37	187.9
90	179.6	152.2	3.257	106.8	176.9
95	210.7	181.2	19.43	135.4	206.3
100	266.6	250.4	51.62	190.9	253.9
105	354.7	322.7	92.04	277.3	325.5
110	474.6	383.0	137.6	371.8	435.6
115	606.2	426.2	187.2	453.4	572.0
120	714.2	453.9	236.5	515.2	714.5
125	769.5	475.7	285.8	559.1	821.6
130	781.9	494.3	334.1	585.4	871.3
135	761.1	507.5	380.1	598.0	870.9
140	719.0	517.0	422.9	603.2	838.5
145	677.6	523.1	462.1	595.0	782.9
150	645.1	532.1	496.6	585.4	720.6
155	612.9	546.7	526.0	589.0	662.2
160	589.4	567.2	549.9	603.2	615.7
165	575.7	587.2	568.5	599.0	585.5
170	579.9	597.3	581.3	563.6	566.7
175	593.7	593.8	588.6	580.9	578.9
180	591.6	596.8	601.2	603.7	591.6
DEG	LUMINOUS INTENSITY:cd				

Zonal Lumens

τ	φ total
0-5	14.33
5-10	57.00
10-15	127.0
15-20	222.5
20-25	340.9
25-30	478.9
30-35	632.5
35-40	797.4
40-45	968.7
45-50	1142
50-55	1311
55-60	1472
60-65	1621
65-70	1754
70-75	1869
75-80	1964
80-85	2042
85-90	2107
90-95	2175
95-100	2262
100-105	2378
105-110	2530
110-115	2718
115-120	2934
120-125	3167
125-130	3403
130-135	3632
135-140	3845
140-145	4038
145-150	4207
150-155	4352
155-160	4472
160-165	4566
165-170	4634
170-175	4676
175-180	4690
	UNIT: lm

Luminance cd/(m2)

G(DEG)	C0/180	C90/270
85	21322	4354
80	12018	4331
75	9358	4485
70	8217	4678
65	7577	4844
60	7197	4989
55	6932	5137
50	6737	5237
45	6580	5322